

DESIGN FOR INJECTION MOULDING

INDEX

3	IDEATION
10	MODEL MAKING
14	DEVELOPMENT
18	FINAL CONCEPT
19	APPENDIX

IDEATION

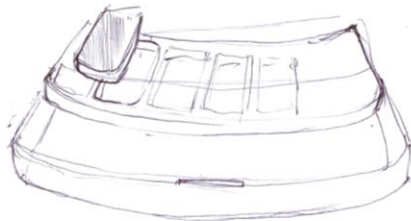
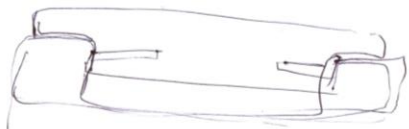
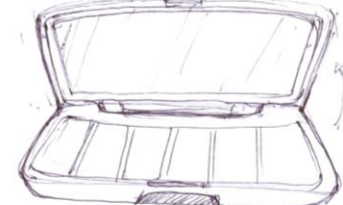
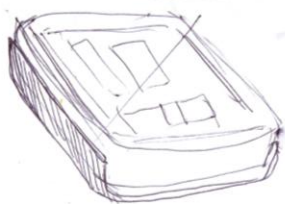
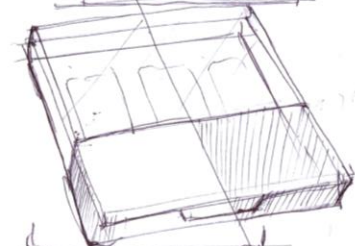
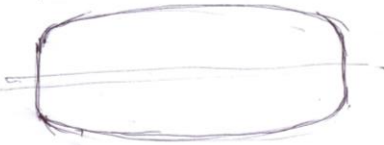
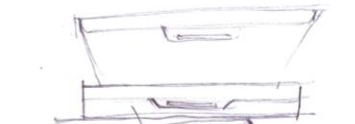
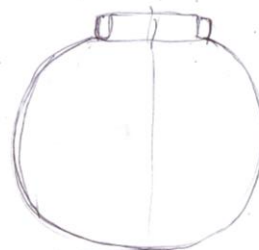
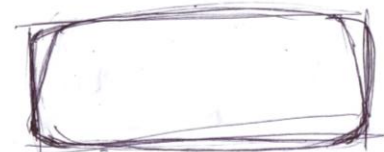
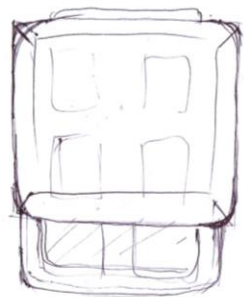

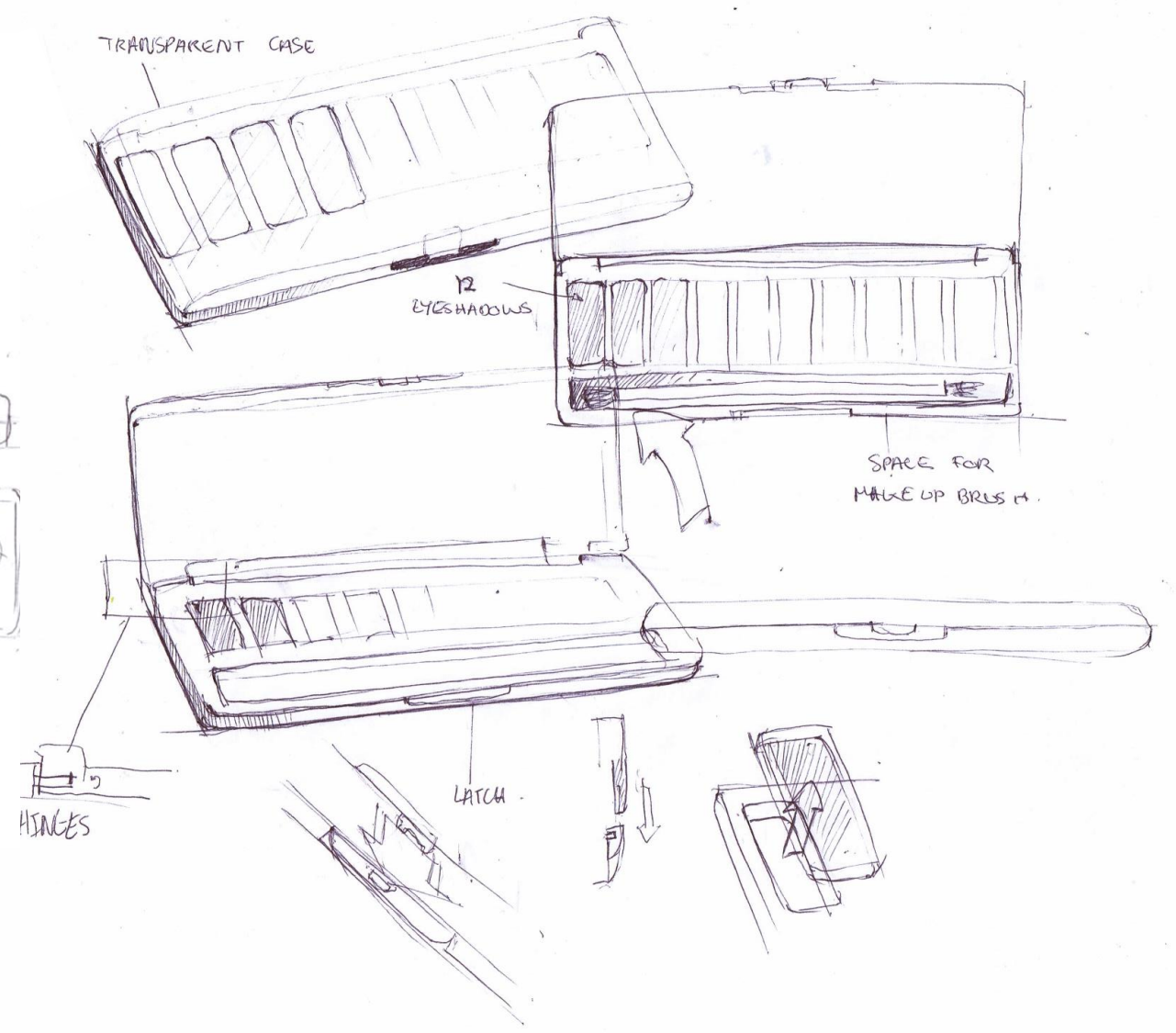
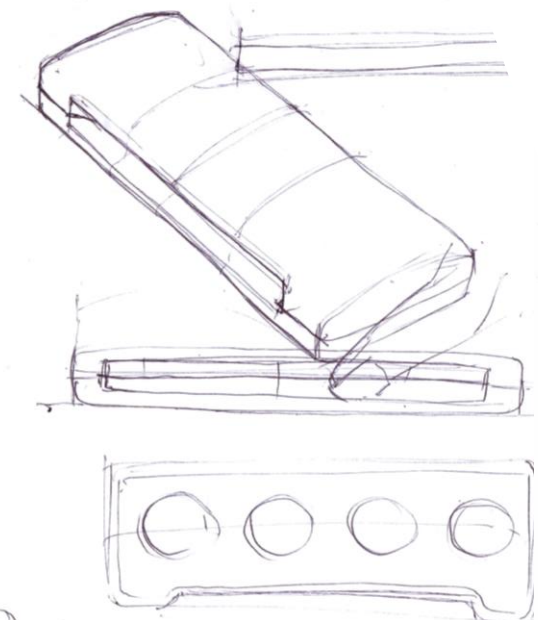
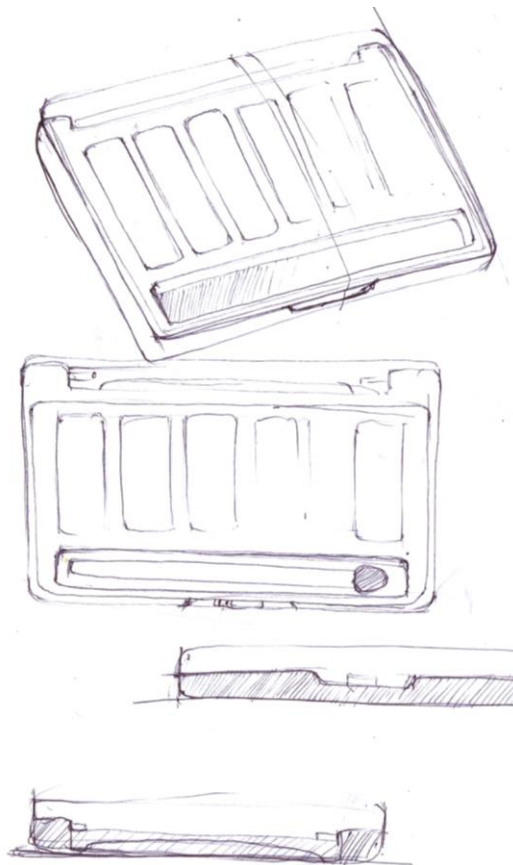

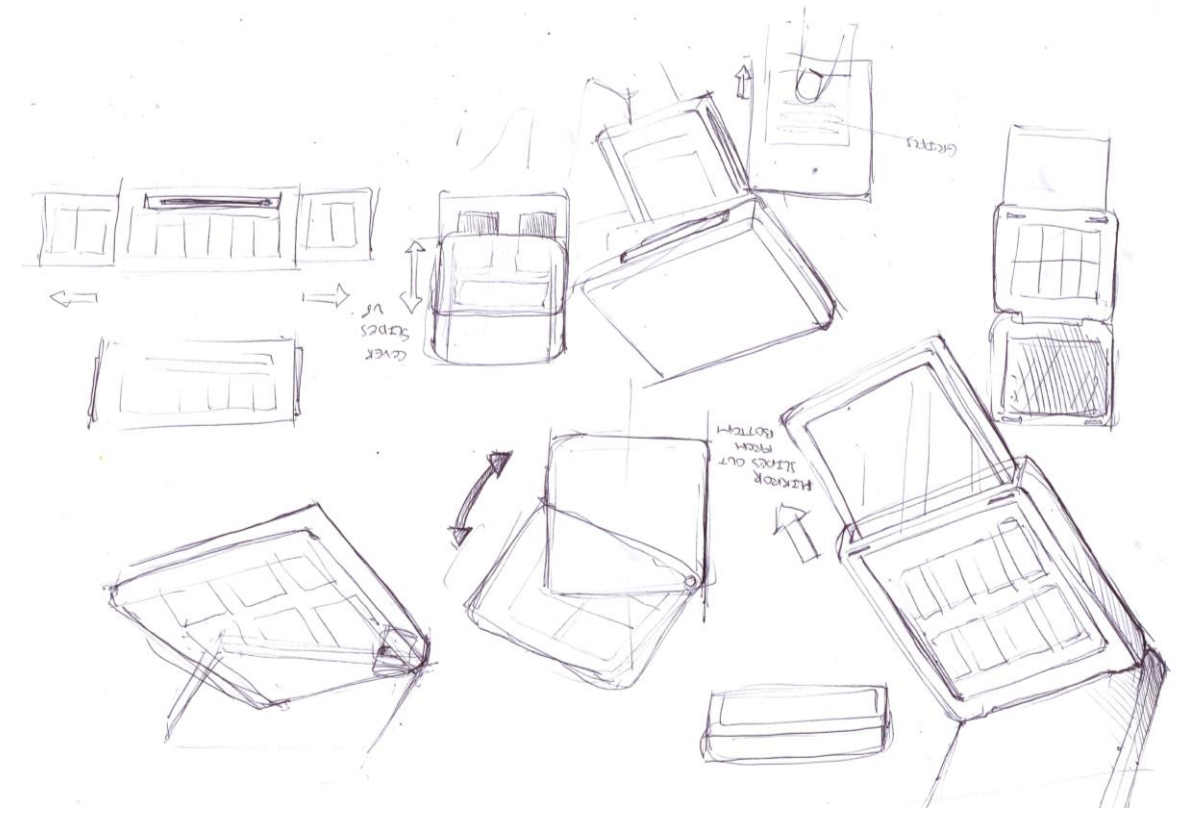
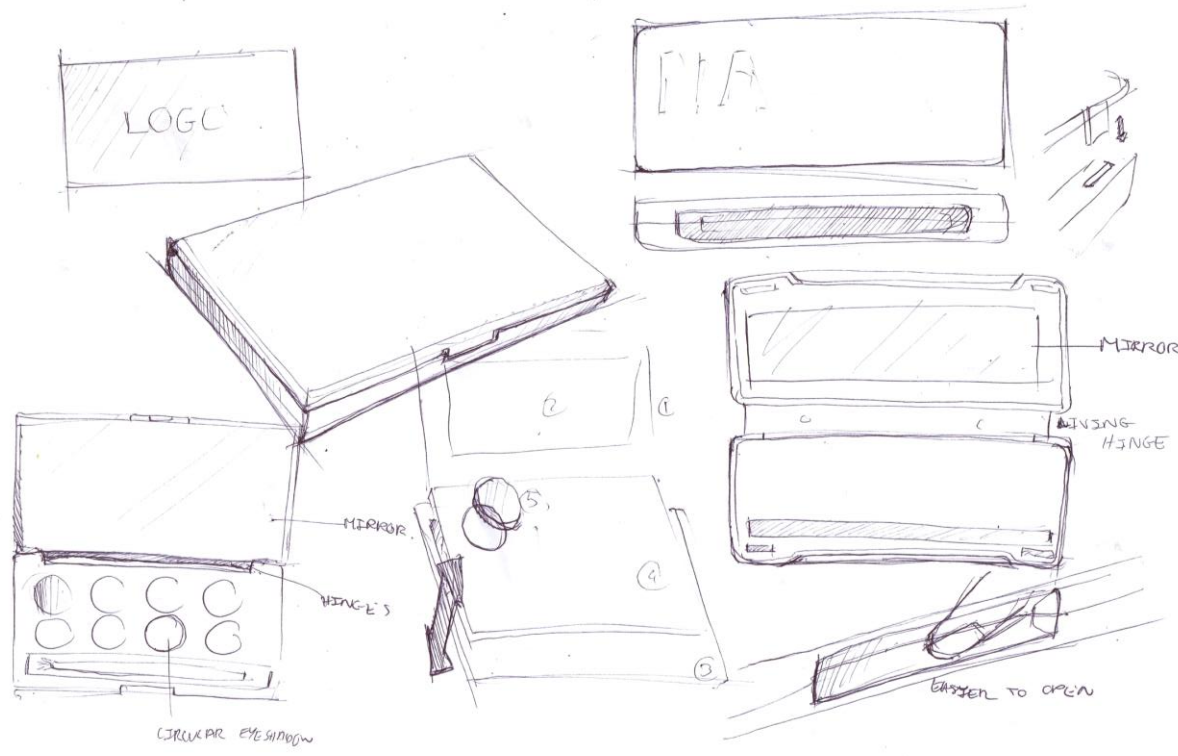

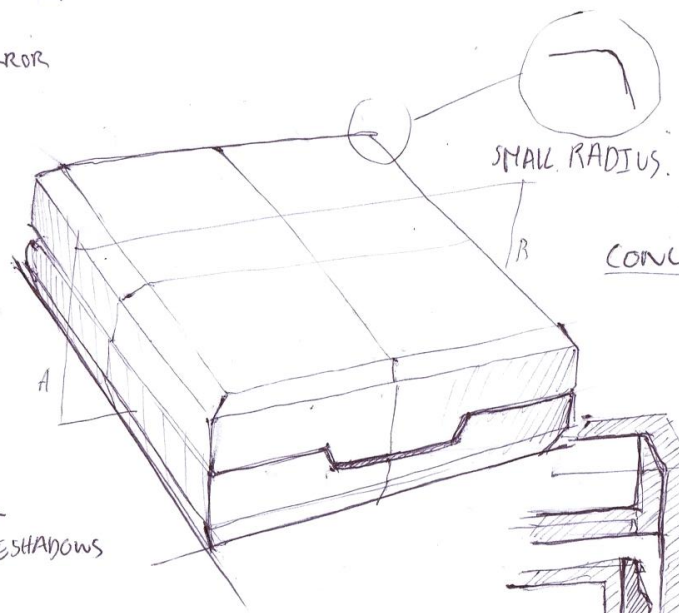
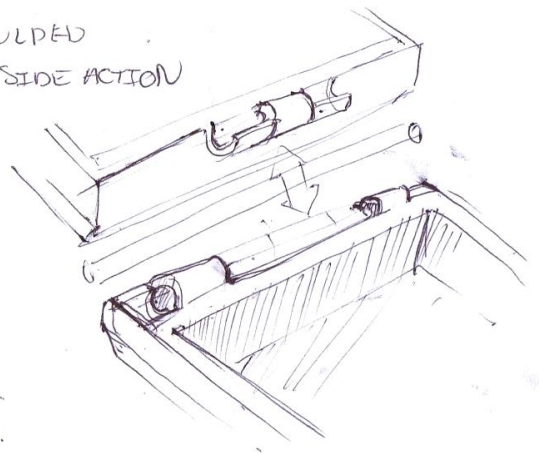
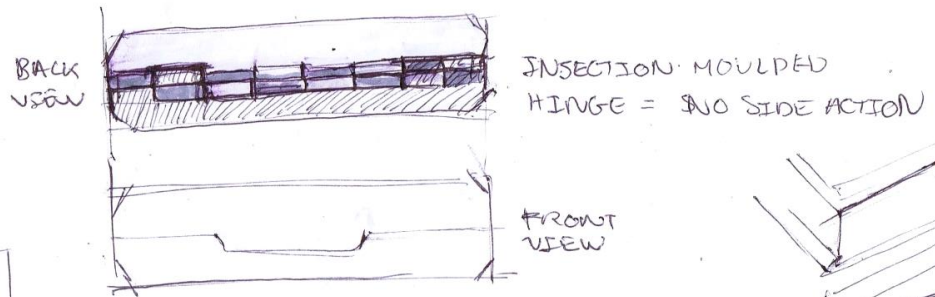

CONCEPT 1

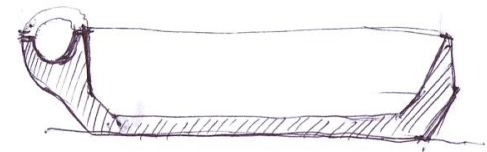
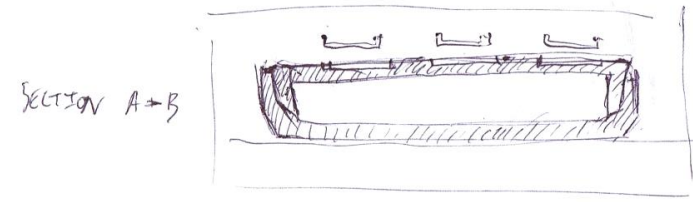
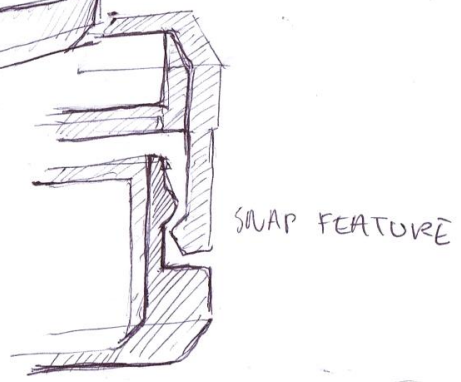

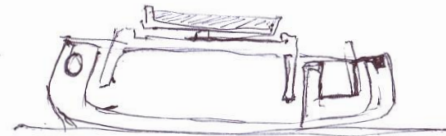
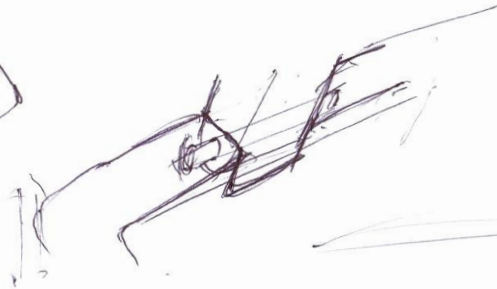
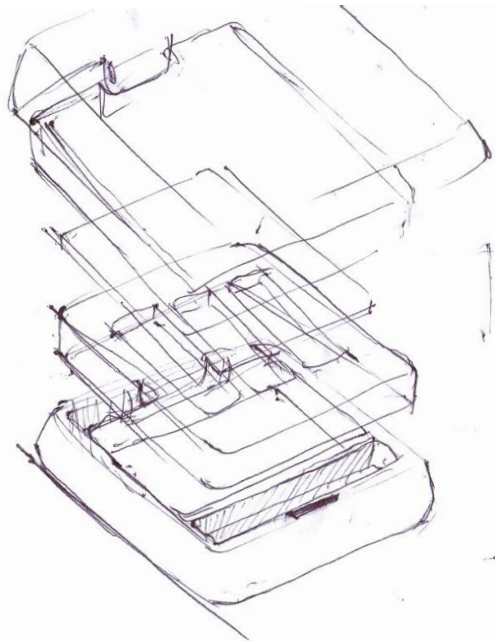

CONCEPT 2

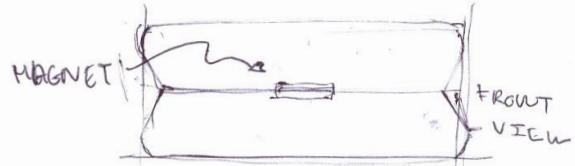
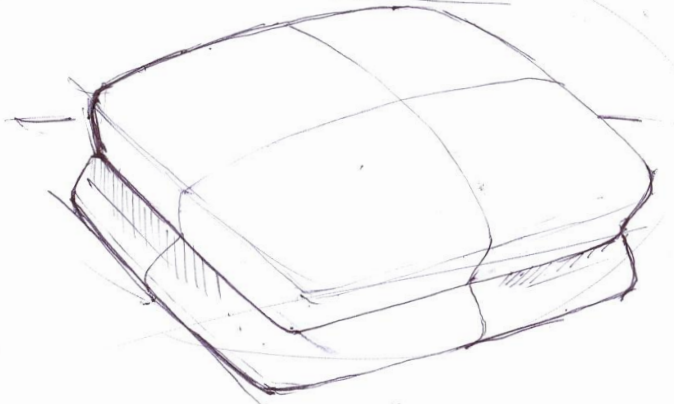

MAGNET

FRONT VIEW

MIRROR

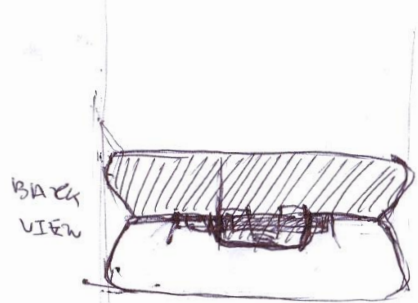

BACK VIEW

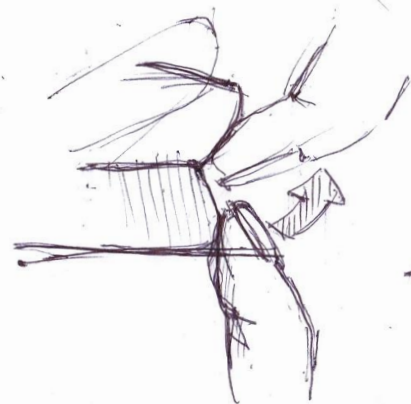

EASILY OPENED

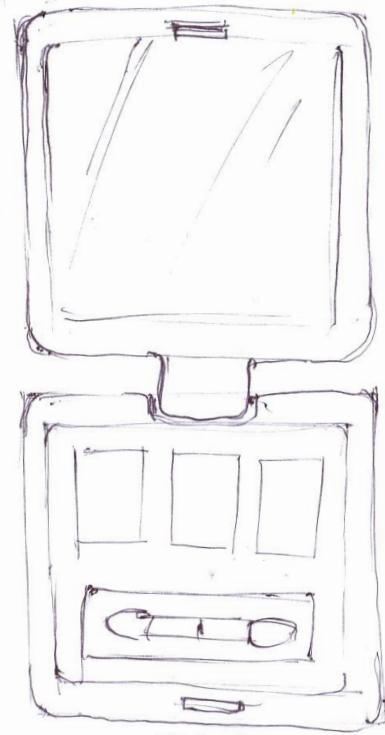

MAGNET

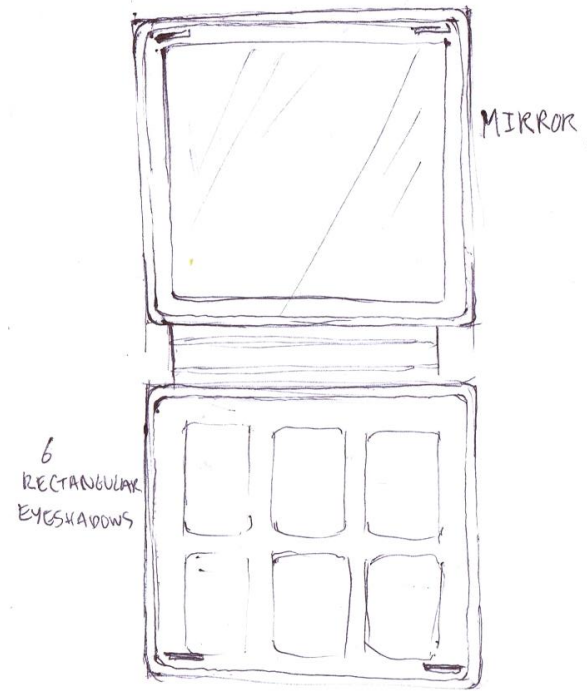

CONCEPT 3

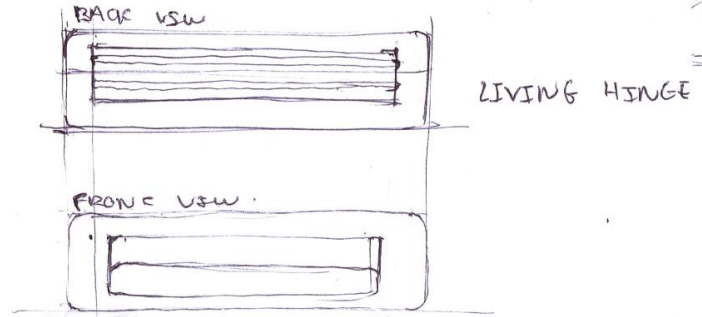
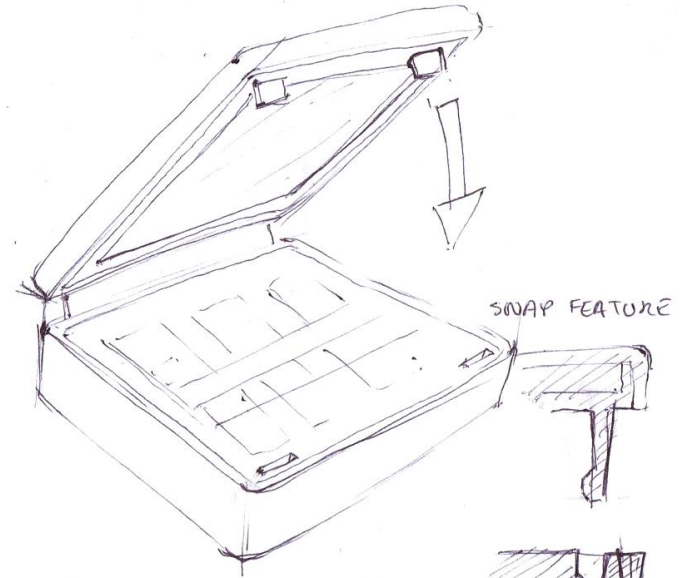
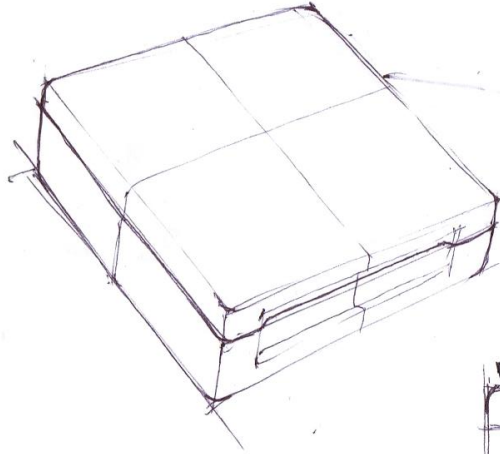

SIDE VIEW

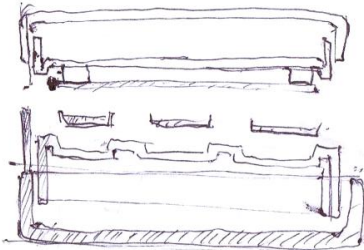

MODEL MAKING





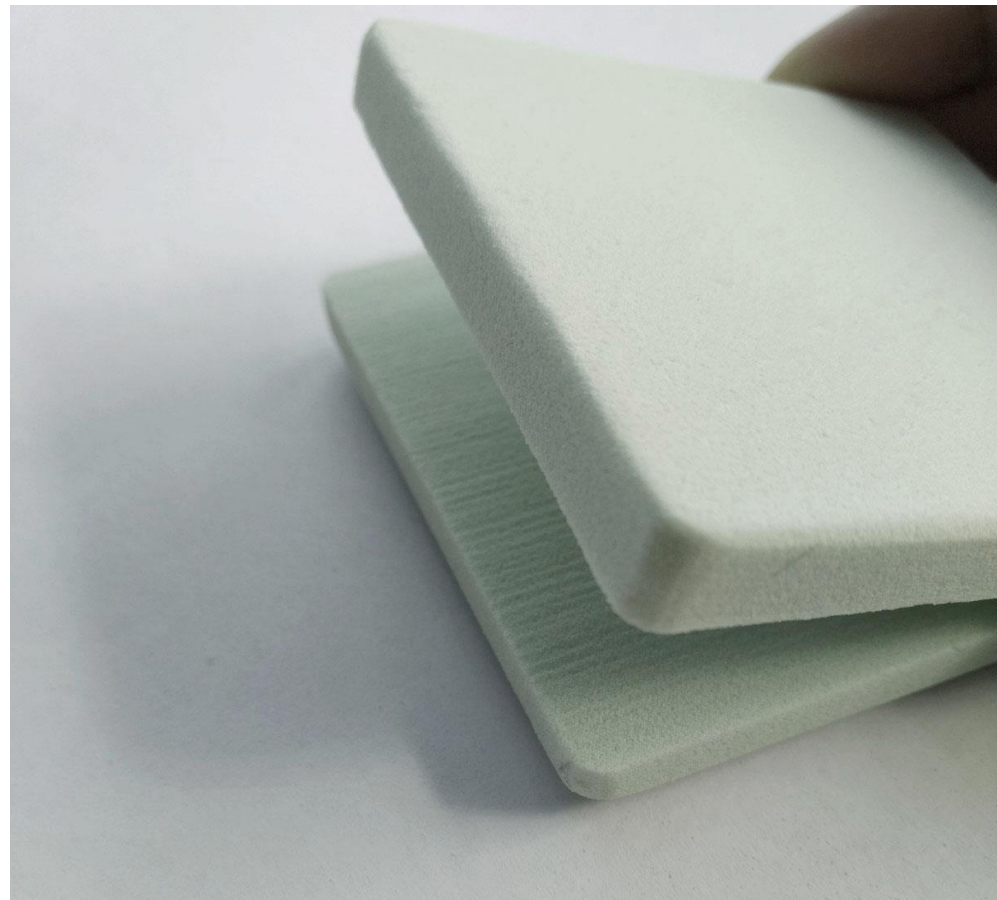

DEVELOPMENT

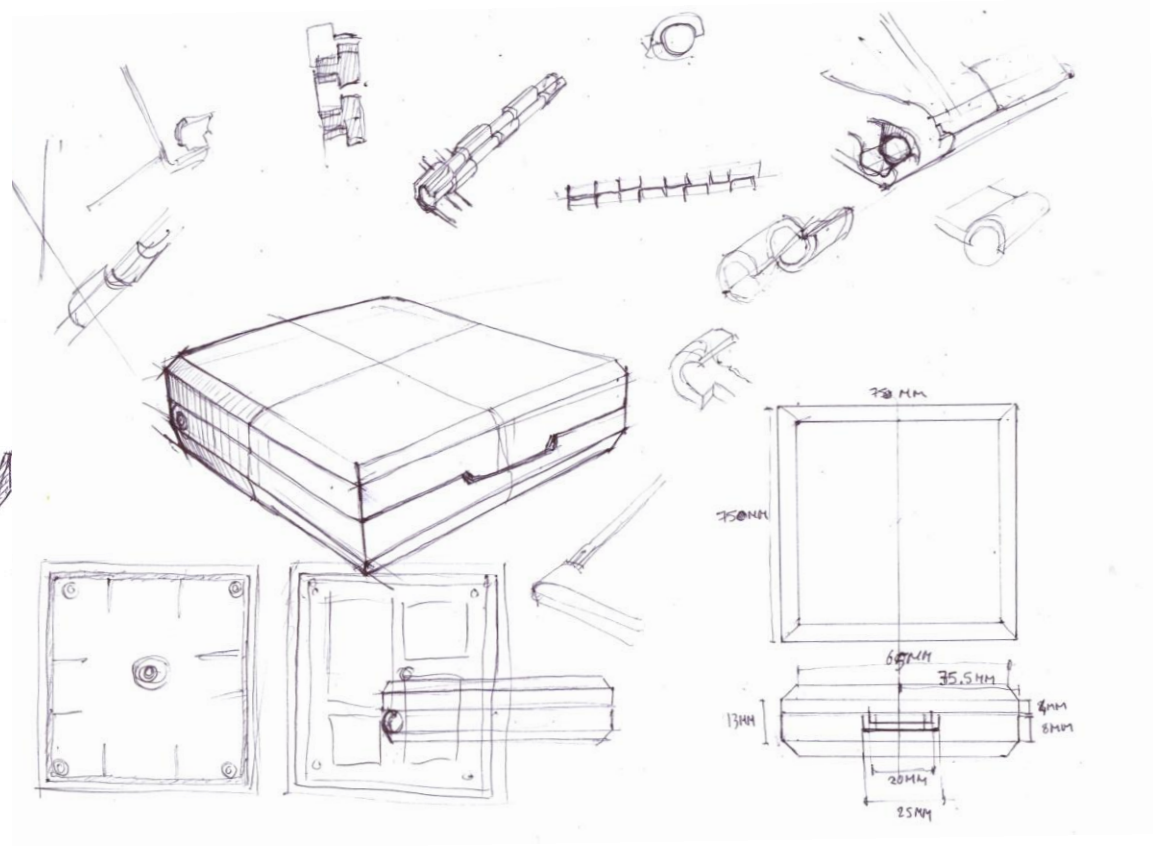
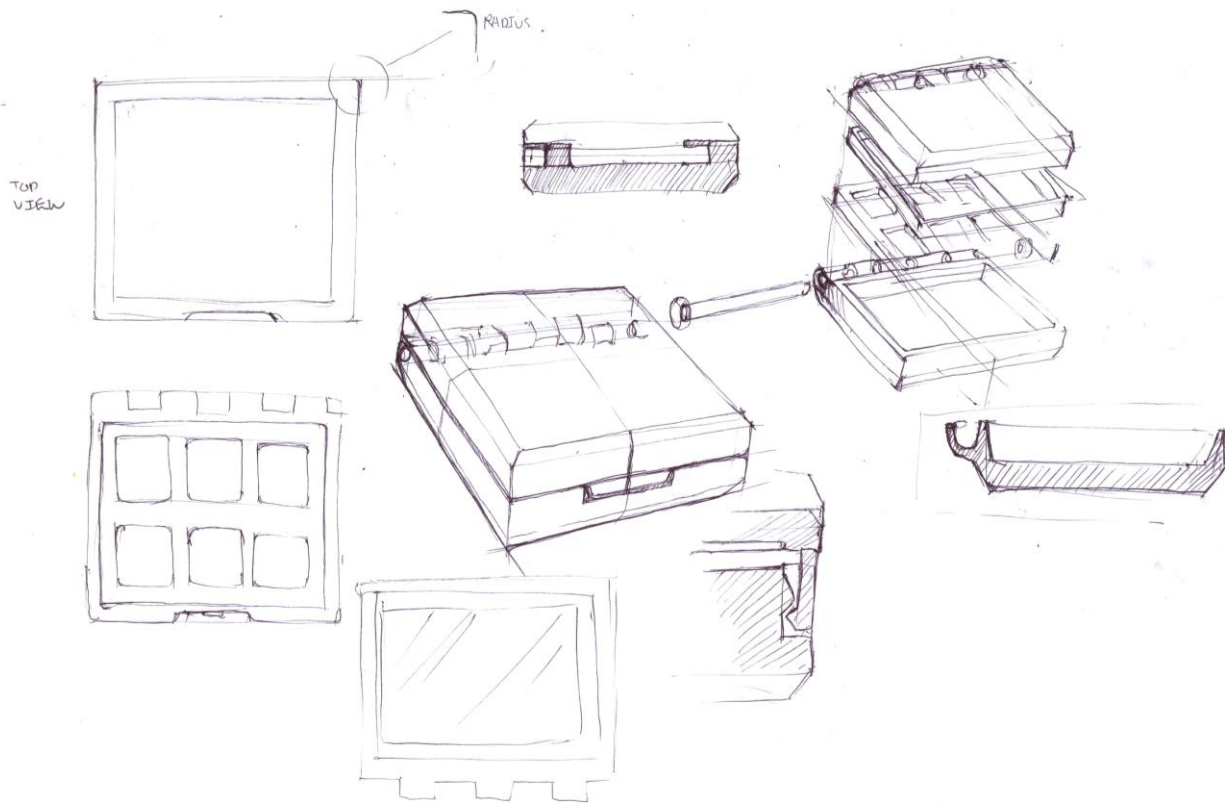

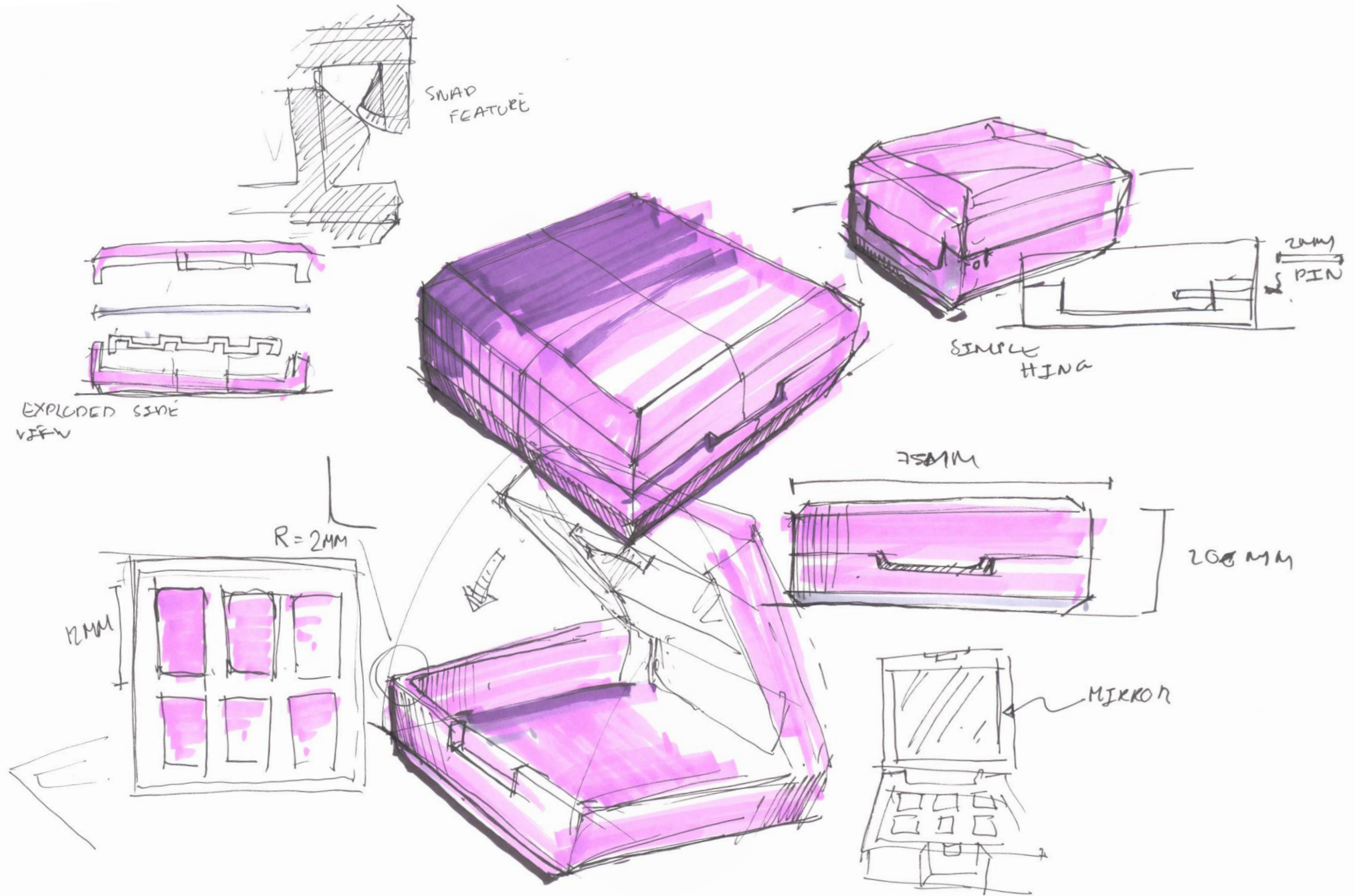

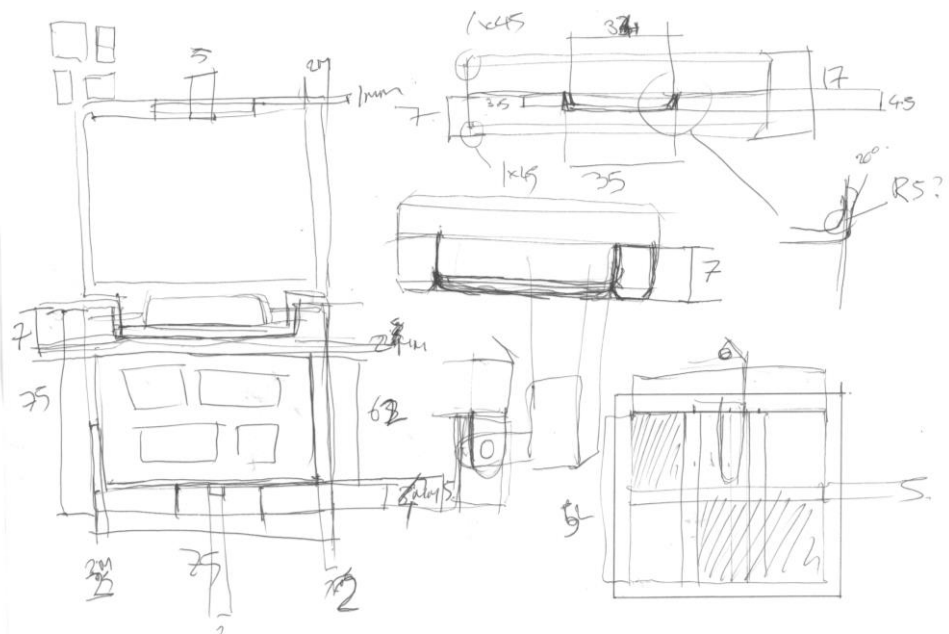
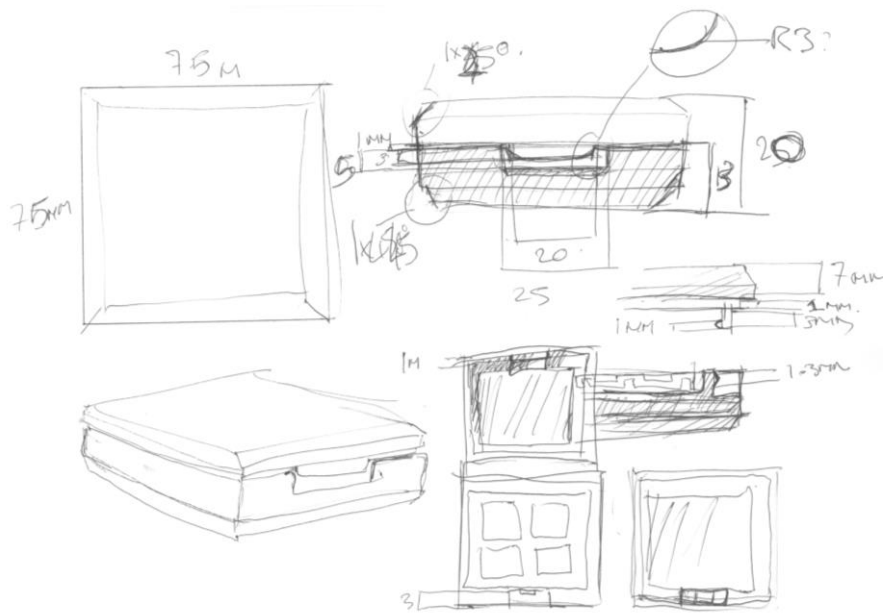
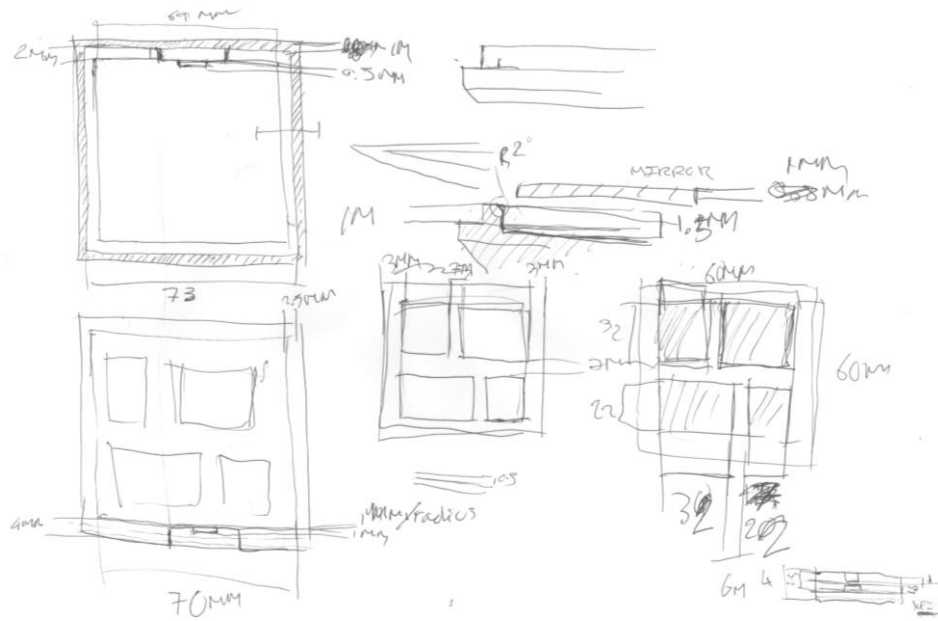
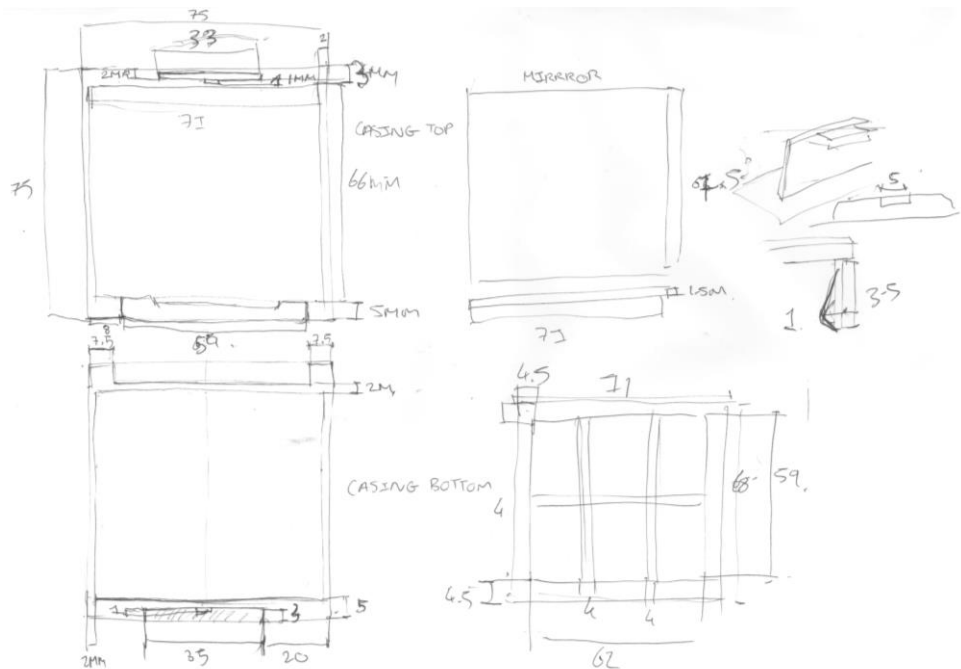

FINAL CONCEPT

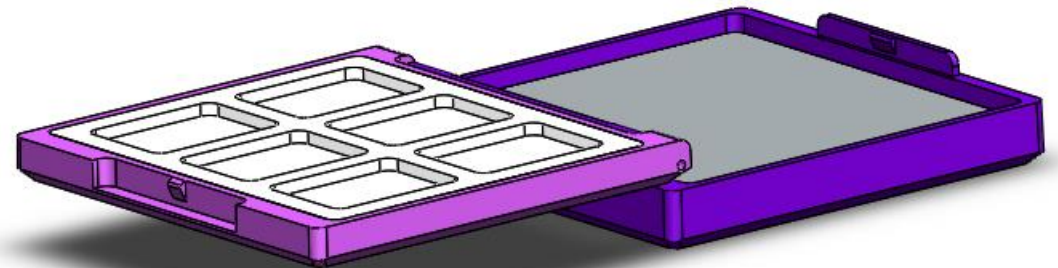
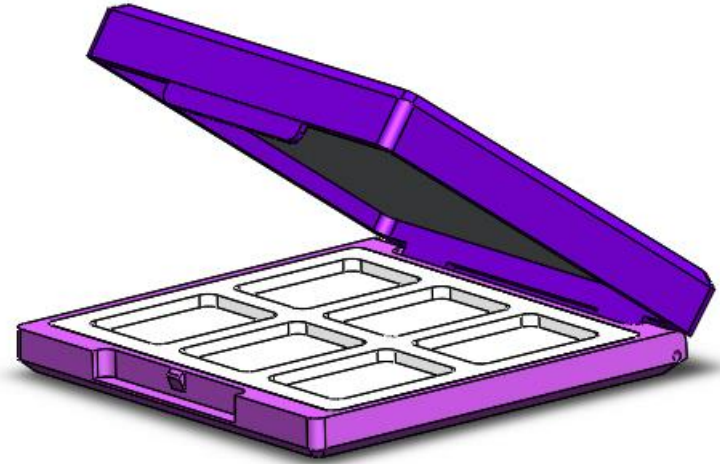
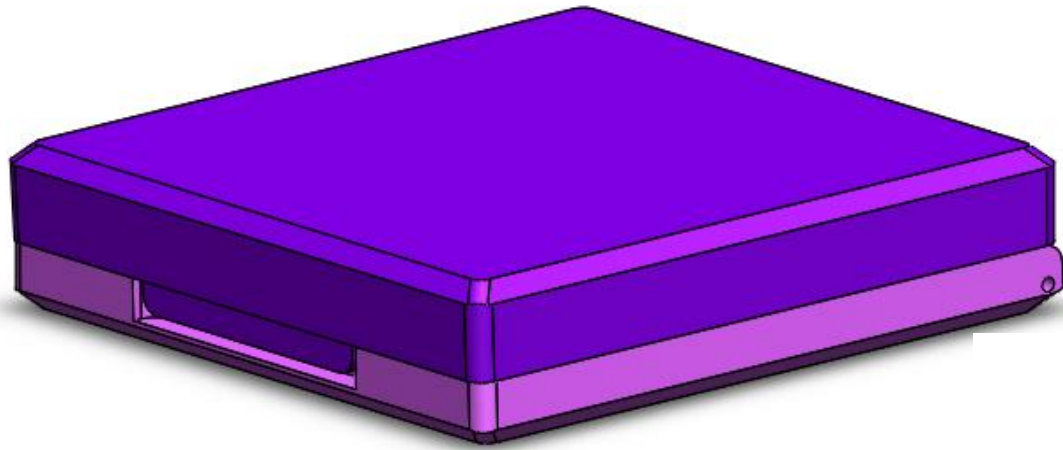

SOLIDWORKS 3D MODEL

APPENDIX

